



OPENMARK III

C-Shaped Permanent MRI system

Shenzhen Anke High-tech Co., Ltd.

Address: Block B, LingYa Industrial Zone, Tangtou No.1 Road, Bao'an District, Shenzhen, 518108, P.R. China

Tel: +86-755-21622518 26688889

Fax: +86-755-26695307 26685908

Email: anke@anke.com

Website: www.anke.com

LinkedIn: www.linkedin.com/company/shenzhen-anke-high-tech-co--ltd

Facebook: <https://www.facebook.com/ankemri>

Twitter: twitter.com/ankeint

Specifications and appearance of the equipment may change without prior notice. Anke reserves the right of final interpretation

Insight Into life



Advanced gradient system

- Combined with Self-shielding & Eddy-'0' technology, ensure a high image quality.
- High level linearity & Powerful output

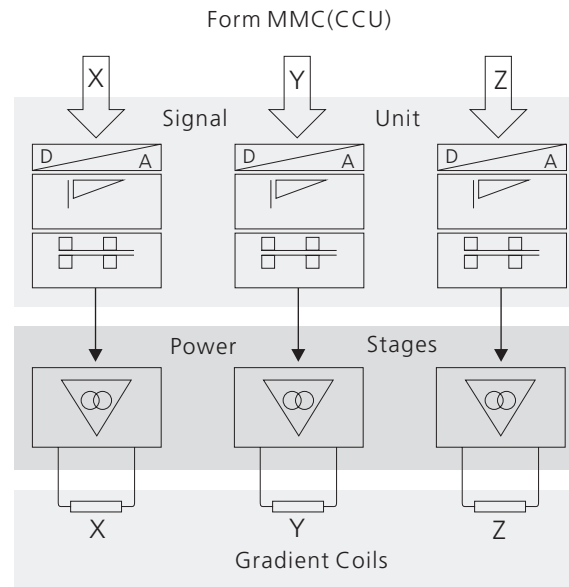

Digital 4 channels RF system

- 4 channels PA receiving coils
- 4 channels A/D Unit
- 4 channels full-digital spectrometer
- Powerful RF output

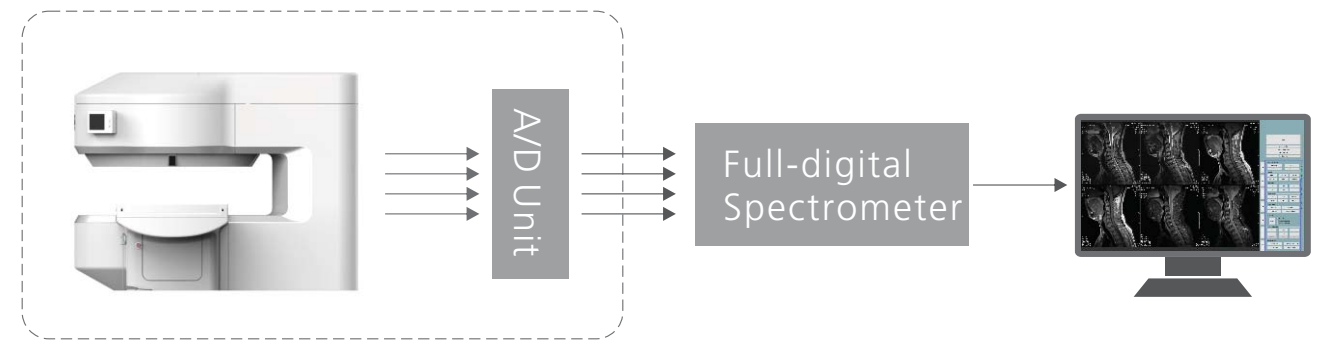

Humanized design

Advocating the combination of technology and humanities, provide a comfortable operation experience to you.

- Large openness C-shape structure
- Touched LCD screen
- Integrated electric patient table



Perfect magnet

- Unique A-shimming technology, ensure a high level homogeneity of magnetic field.
- Intelligent temperature control system, supply a high stability of magnetic field.

Outstanding PA receiving coils*

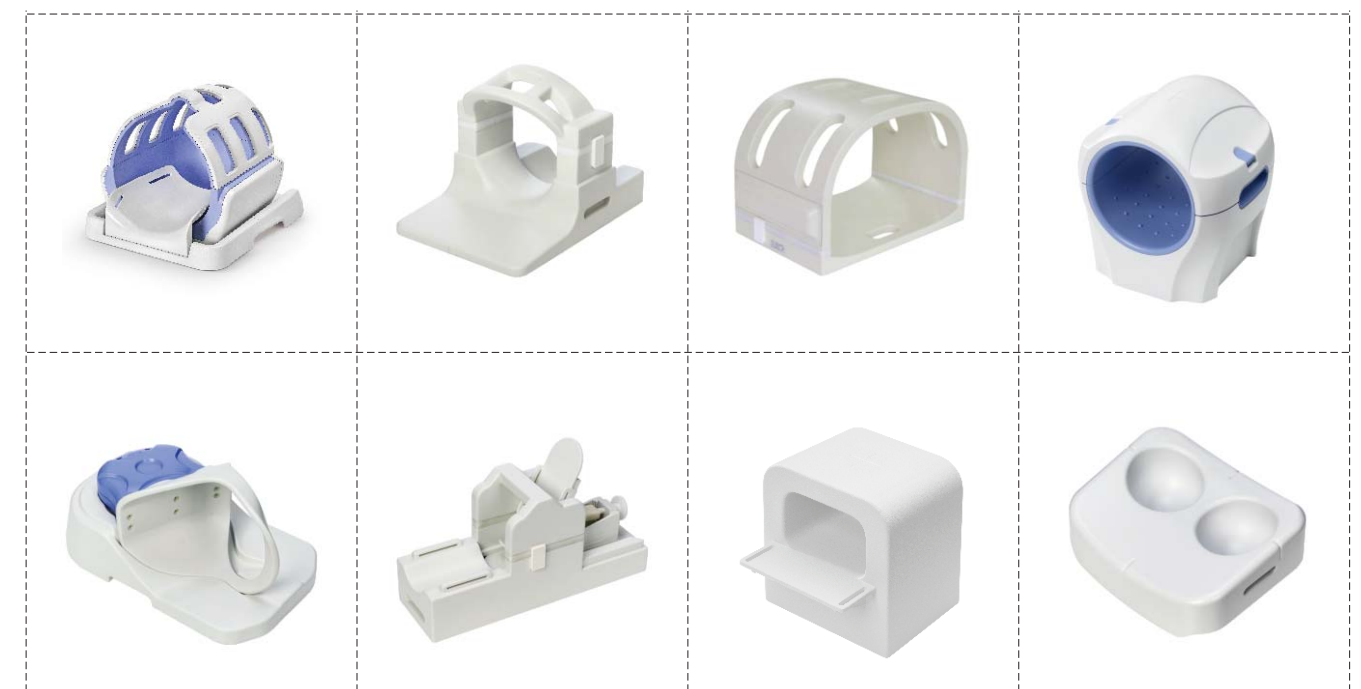

Marked with *** means it is not a standard offer, please contact us for further information

Clinical images

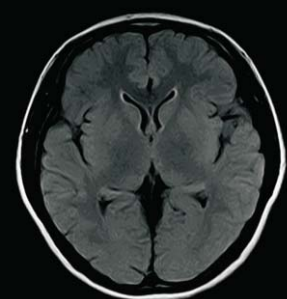

Brain T2_FLAIR

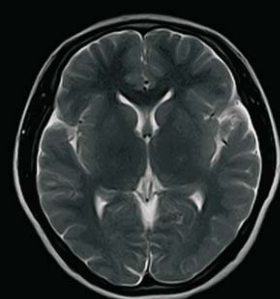

Brain T2WI

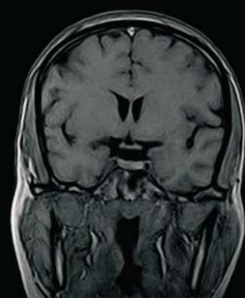

Brain T1WI_GRE3D

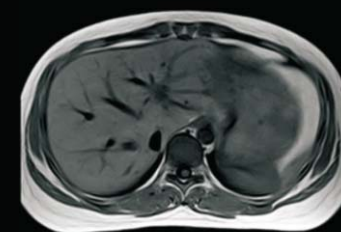

Abdomen T1WI



Abdomen STIR

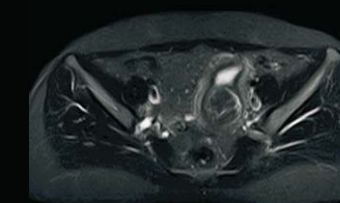

Pelvis STIR

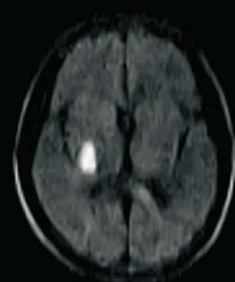

Brain DWI_b1000

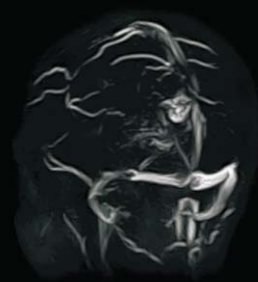

MRV_TOF2D

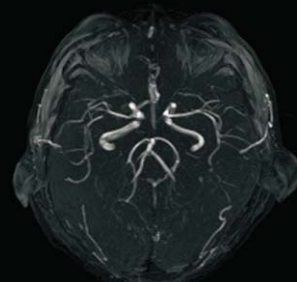

MRA_TOF3D



Pelvis T2WI

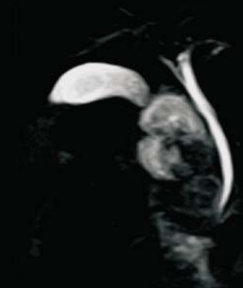

MRCP

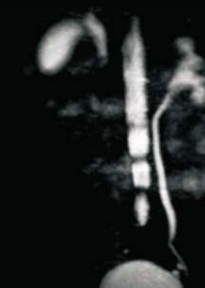

MRU



C-Spine T1WI



C-Spine STIR

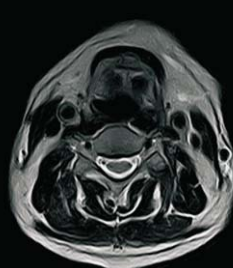

C-Spine T2WI



Hip STIR



Knee DIXON

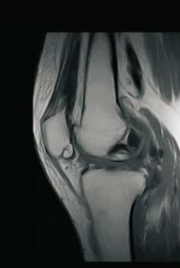

Knee T1WI



L-Spine STIR



L-Spine T2WI



T-Spine T2WI

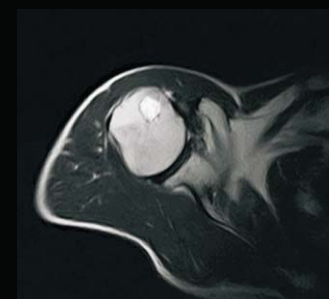

Shoulder T2WI



Ankle STIR

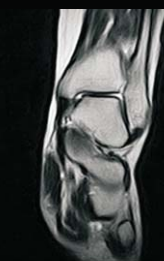

Ankle T2WI

Low operating cost

Meet your clinical application with convenient operation experience, save your 80% operating cost.*

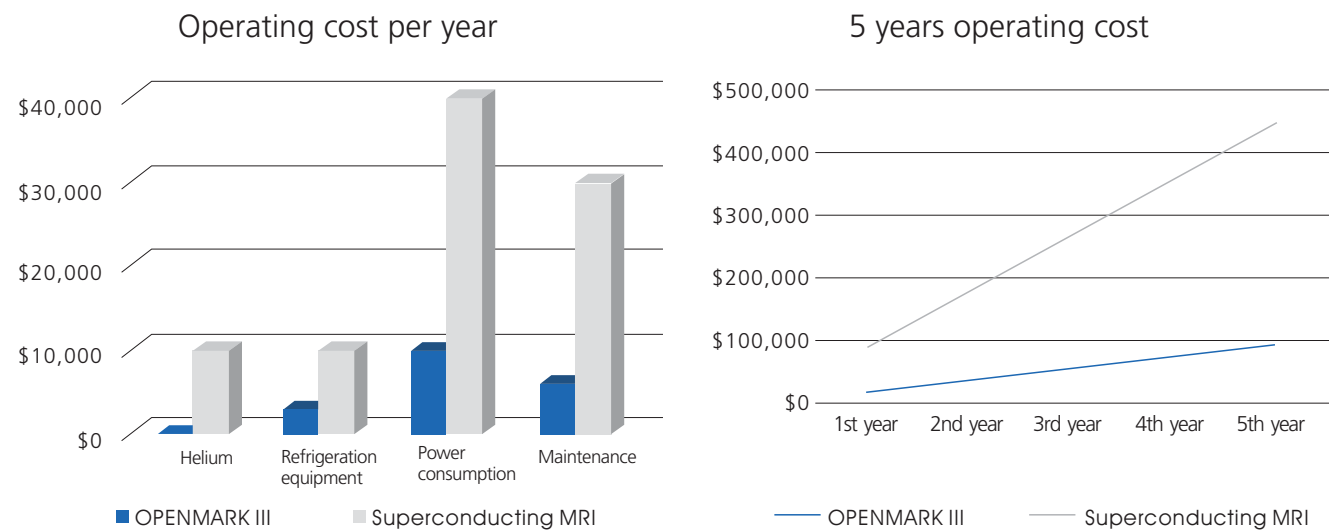

Flexible site design

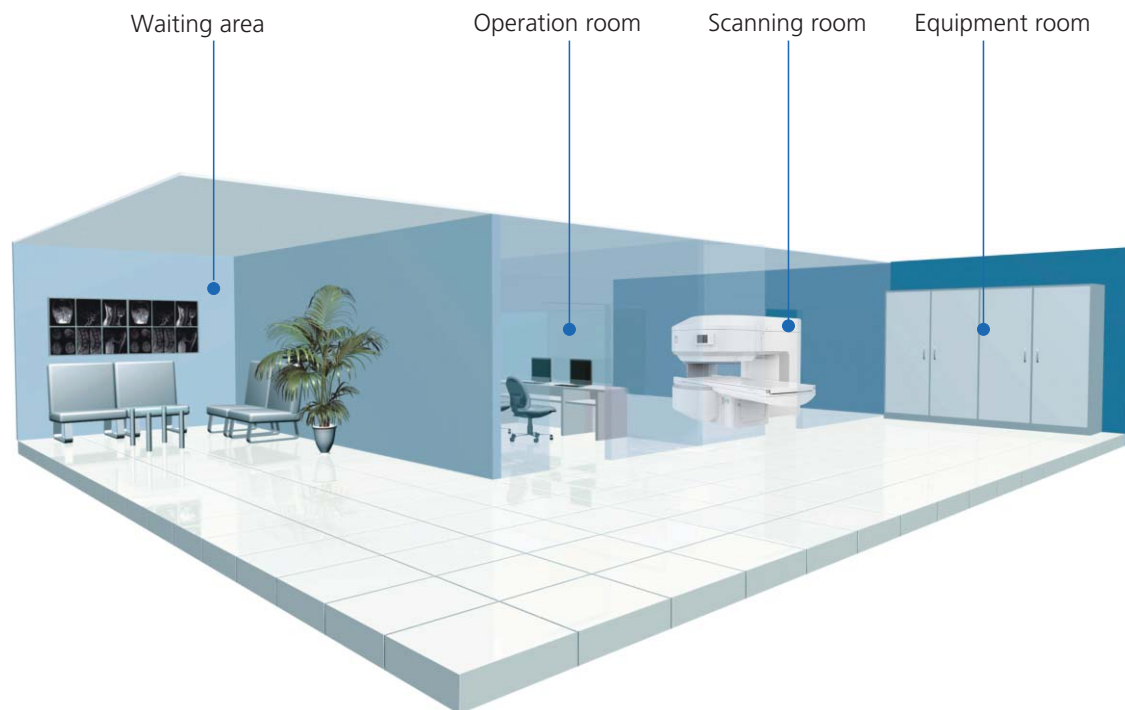

The sample data is for reference only, the actual cost depends on the customer's operation and maintenance.

All-around Service Support



Service response within 24 hours;



Rich spare parts backup and fast delivery;



Efficient service network, over 100 service engineers.

